

TruPunch

The time-saving
technology



Punching – versatile with strong future potential

Punching encompasses far more than just making holes in sheets. You can manufacture complete parts on a punching machine. Reshaping processes open up new dimensions for you. The versatility of the technology is the result of the wealth of tools used. With appropriate loading and unloading aids, you can even automate your production. For many applications, punching is a true time-saving technology; use punching machines for specific applications to help secure the future success of your company.

Discover the versatility of punching with example parts.

The fascination of punching 4–7

This is how punching has constantly improved.

One technology – many benefits 8–9

Focus on tools, machine concept, and automation.

Pull out all the stops **10–17**

The TruPunch machine range.

Our machines in detail **18–25**

Find the technical details of all TruPunch machines at a glance.

Technical data **26–27**

Our comprehensive services and personal support will give you a competitive advantage.

TruServices. Your partner in performance **28–29**

With TruConnect, you can optimize your value creation process.

The best solution for your Smart Factory **30**

The fascination of punching

From 0 to 1600 in one minute? Only a punching machine can manage that. In just 60 seconds it can punch 1600 strokes in your sheet metal. But punching can do far more than that: It creates contours, forms sheet metal, and transforms surfaces. Tapping, embossing, marking, engraving or deburring? With the right tool, your punching machine can become a multipurpose solution.





- **Punch, reshape and insert threads all with one machine**
- **Unbeatably economical for many applications**
- **Part variety thanks to clever tools**



79

**applications
provide you
with endless
opportunities:**

- 44 standard geometries
- 10 slitting applications
- 20 forming applications
- 5 marking tools
- Bends up to 90°
- 360° tool rotation

1600 strokes in 60 seconds

– only a punching machine can manage that.



142840

different configuration variations are offered even by the simple round punch. This standard tool enables you to modify the diameter, beveled sections, and coatings in almost any combination.

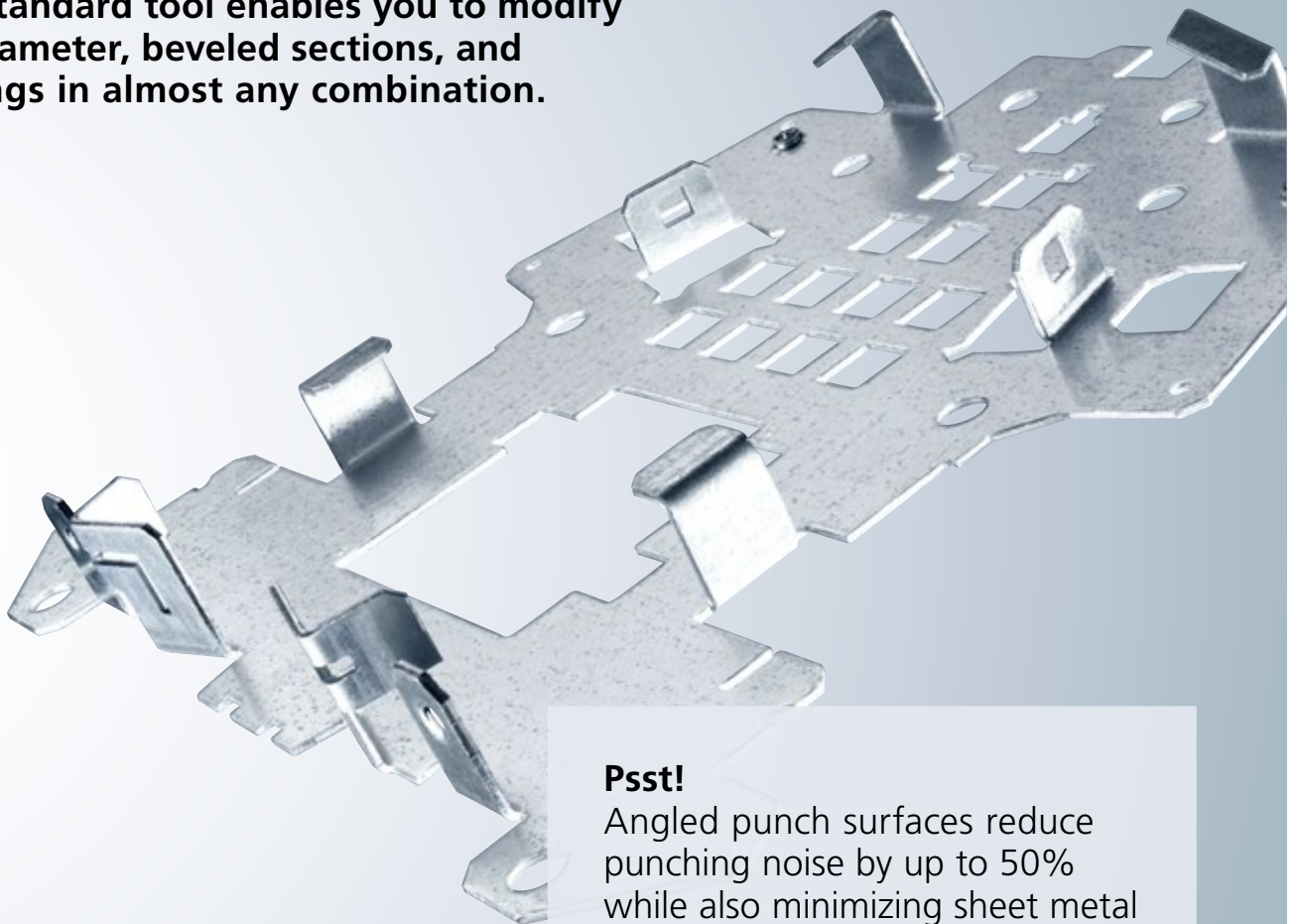

Psst!

Angled punch surfaces reduce punching noise by up to 50% while also minimizing sheet metal distortion. When you order tools from TRUMPF, these bevels are even available free of charge.



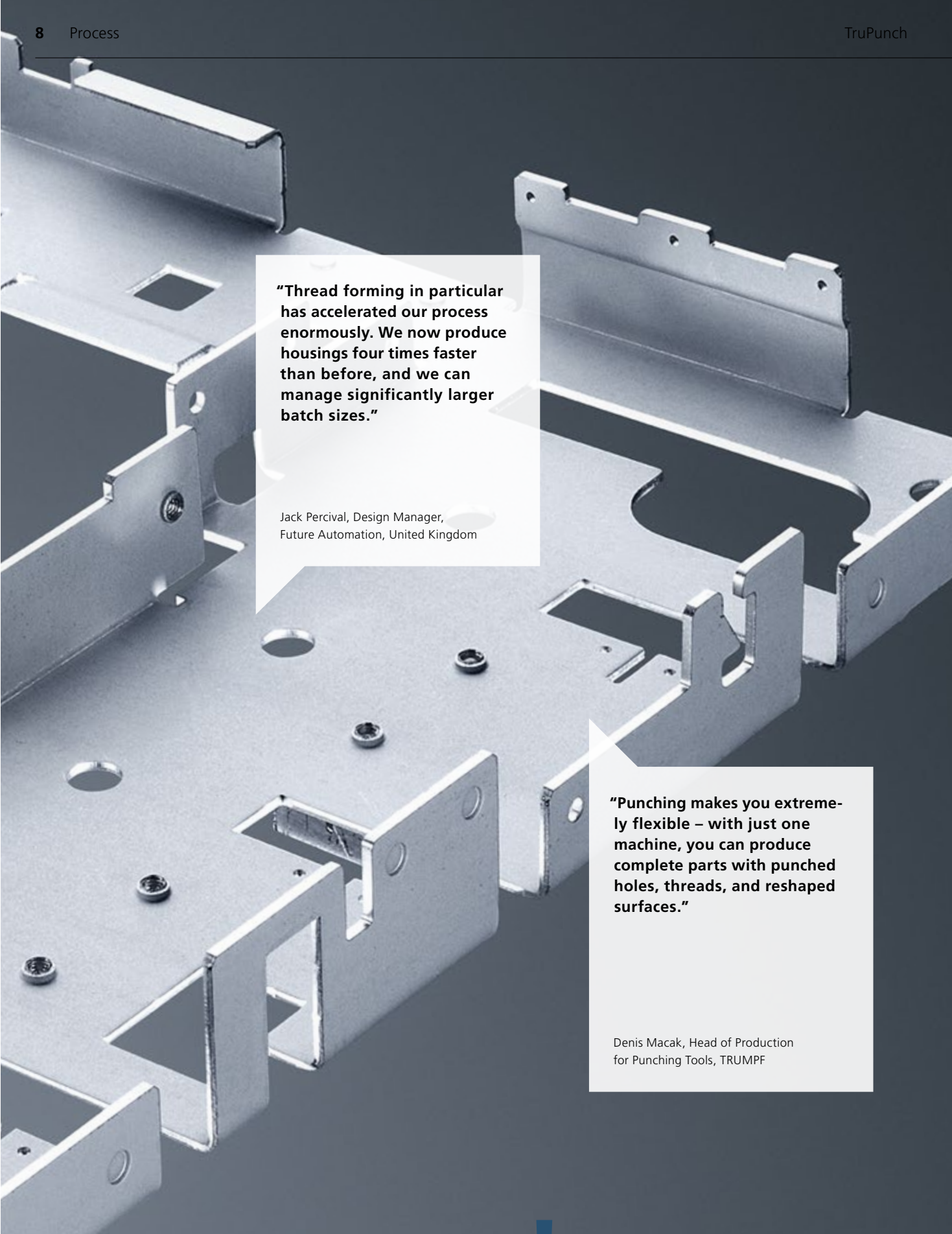

“Thread forming in particular has accelerated our process enormously. We now produce housings four times faster than before, and we can manage significantly larger batch sizes.”

Jack Percival, Design Manager,
Future Automation, United Kingdom

“Punching makes you extremely flexible – with just one machine, you can produce complete parts with punched holes, threads, and reshaped surfaces.”

Denis Macak, Head of Production
for Punching Tools, TRUMPF

Material variety – good to know

A punching machine lets you process more than just sheet metal. We would be happy to offer you tailored advice.



One technology – many benefits

Punching technology has continuously developed in the last few years: look forward to a new level of part variety, user-friendliness, and quality. High-quality punching tools therefore now leave behind virtually no punching burr. Set up, sorting, and removal is easier than ever before – this means that you can produce even small lot sizes with flexibility as well as efficiently.

Forming to geometric perfection

Only a punching machine can achieve geometrically precise shapes to the highest levels of quality – with no seams or spatter and no waves or scratches. This means for example that you can create a perfectly round circle or a perfect square.

➤ Geometric perfection without reworking

Complete processing

Punching, slitting, forming, counter-sinking, tapping, rolling, marking, and deburring: A punching machine is fully capable of performing all of these processing steps. This saves time, as setup and programming only needs to be carried out once. The benefit to you: You can manufacture a wide range of parts entirely on just one machine – and these processes can be fully automated if desired.

➤ Complete processing with just one machine

Punch faster

If you are producing a number of identical shapes in one go, punching is unbeatably fast and has no competition when it comes to price – TRUMPF punching machines guarantee this with nearly limitless options for slitting, forming, and bending.

➤ Unbeaten throughput

Perforated sheets are a classic example:

For this application, punching machines outperform all other technologies in terms of speed and cost-effectiveness.

Find out for yourself with this example:

Perforated plate with 15510 holes, medium format 2500 × 1250 mm, plate thickness of 1 mm, hole diameter of 8 mm

Result:

➤ You can reduce processing time by 76% with a single tool, or by as much as 95% with a cluster tool!

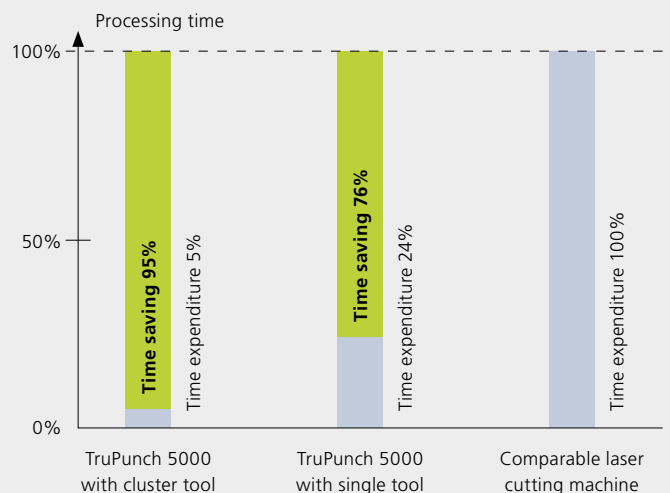



Pull out all the stops

Smaller batch sizes with increasing variance and quality requirements – how can you meet the demands of your customers in future? Modern punching machines from TRUMPF provide you with enormous opportunities: with versatile tools, precise processes, and intelligent automation solutions. Rely on the best punching solution for your future – and get the edge over the competition.





Clever tool concept

With high-quality tools from TRUMPF you can meet any customer wishes. The special thing about it is: The punching head can tilt and turn all tools to any desired angle. All tools can be positioned at any tool station, regardless of their size.

Reliable machine processes

Intelligent functions and a wide range of discharging and sorting options assist you in working on the machine and make your processes smooth and reliable.

Earn more automatically

You can easily automate your TruPunch; a wide range of options are also available for integrating it into existing production systems. Intelligent possibilities for automation take pressure off the operator and increase your throughput.

Short setup times and high productivity

Smooth processes and high machine availability

Lower manpower, higher throughput



Tools: Punching with brains

Whether a standard or special solution: always choose the right tool from the largest range on the market. We manufacture all punching and reshaping tools ourselves, using top-quality steels – to ensure that they meet your highest requirements. Look forward to short delivery times for standard and special tools and a wide range of additional services such as punch beveling at no extra charge.

The right tool for every application

Whether for marking, engraving or deburring: all TRUMPF punching and forming tools are available as standard tools or, if required, as special tools.

You can use our conventional punching tools on TRUMPF punching and punch laser machines of any generation. These tools are particularly durable thanks to their high-quality coating. They are available in a wide variety of shapes and sizes. All you need to use these tools is the RTC universal tool cartridge.

Punching machines can do more than make holes in sheets. Reshaping means punching in the third dimension – producing countersinks, bridges, eyelets, and many more features besides. These tools can also form threads directly into sheets. This can be performed in just one step and is therefore cheaper than using weld nuts or insert nuts.

Thanks to the intelligent punching head and corresponding tool, you can process a huge variety of challenging components entirely on one machine, without even causing burrs if necessary. This can be achieved cost-effectively, even for small quantities – thanks to low tool costs and setup times.

When developing our punching tools, we place a great deal of emphasis on dialog and close collaboration with you. And what if there is still no suitable tool for your requirements? Our specialists develop special tools for your requirements together in a team with you. Thanks to our in-house manufacturing and intensive testing, you can rest assured that your new tool will work properly, right from the start.

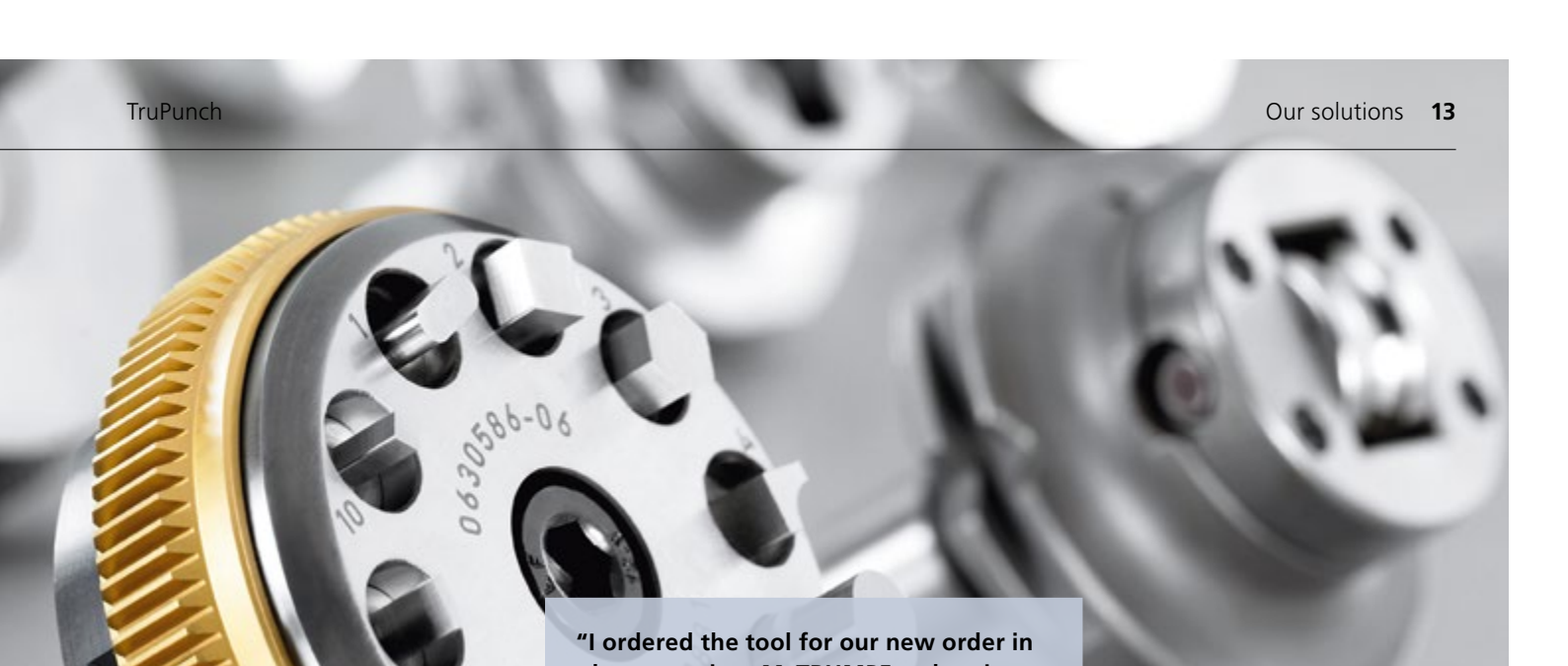

"I ordered the tool for our new order in the convenient MyTRUMPF e-shop in the morning – and it was shipped the same day."

Uwe Hoffmeister, CEO of B&H Metalltechnik,
Germany

Clever setup saves time

Your TruPunch machine offers an unbeatable short setup time thanks to its monotool punching head, MultiTools, and tool cartridges.

The fully rotating tool holder also acts as the drive for TRUMPF MultiTool tools. You can integrate up to ten punches in a single MultiTool – this increases the tool capacity of your machine. Each individual tool in the MultiTool can of course be rotated in any direction. This enables you to work more productively and reduce investment costs and setup time.

TRUMPF tool cartridges are made from fiber-reinforced plastic and provide a variety of benefits: Their low weight enables high acceleration values to be achieved on the machine while ensuring that even heavy tools are securely held in place. Thanks to the carrying aid, you can transport three cartridges with one hand. Labeling with colored clips helps you identify cartridges at a glance.

Did you know?

All TRUMPF tools come from our own manufacturing facility. We ship 80% of our tools within 24 hours. You can place orders easily and conveniently in our MyTrumpf e-shop.



Clever, high-quality tools manufactured in-house:
Punching tools from TRUMPF.
www.trumpf.com/s/imbkg4



“As our customer you can find the perfect machine for your needs that also meets your requirements for power and cost-effectiveness. Every machine offers you a wide range of functions that support you in your day-to-day manufacturing.”

Andreas Kettner-Reich,
Head of Product Management and
Technical Sales Support, TRUMPF

Built for your success

From setup to punching to discharging your parts: TruPunch machines are designed down to the details to provide you with the greatest possible benefits. This results in highly precise and scratch-free parts – you will still be able to rely on them one hundred percent, even after many years.



A worthwhile investment:
Punching machines from TRUMPF.
www.trumpf.com/s/avjtu2





360° punching freedom

An all-rounder instead of a revolver: The monotool punching head can rotate any tool to any desired angle. This reduces material use, the number of tools needed, and setup time.

The freely rotating punching head gives you unrivaled flexibility. The ability to align each tool differently reduces the total amount of tools you need. This reduces your investment costs. The rotational axis in the punching head provides you with full freedom of motion and enables functions such as MultiTool, deburring and rolling technology, as well as thread forming.

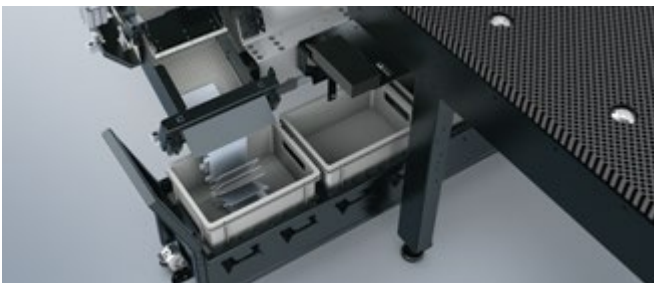

Discharging, unloading and sorting

The discharging and sorting options of TruPunch machines enable your punching production to reach its full potential.

Good parts travel along a chute onto the conveyor belt and from there are transported reliably, safely, and with minimal material wear to the operator, who can remove them without interrupting production. The large parts flap automatically unloads parts up to a format of 400 mm x 600 mm into containers or onto Euro pallets or conveyor belts. Your machine automatically sorts parts up to 180 x 180 mm in size into up to four different boxes.*

* Values apply to the TruPunch 1000 (S19).



Your machine – your concept

From entry-level processing to high-end operation: what machine concept best suits your needs?

TRUMPF offers customized machine concepts for individual requirements. The hybrid concept of the TruPunch 1000 (S19) has been developed specifically for entry-level users: Sheets are not moved in the Y-direction, minimizing the required installation space. Its electrical drive makes it particularly economical. All other TruPunch machines work according to the sheetmover principle. This is where the punching head is still while the sheet metal moves. Your stamping drive offers large reserves of productivity – ensuring that you are ideally equipped for medium- to high-power operational ranges.



Your machine thinks for itself

Intelligent functions shorten your processes and help you to get the best possible performance from your system.

Thanks to Smart Functions, your machine can detect problems and sometimes even rectify them by itself. For instance, the Smart Punch Monitoring sensors check whether a hole has actually been punched in the sheet prior to tool changing. This enables the machine to detect possible punch breakage and inform the operator. Smart Load helps you to align the sheet on the machine, while Smart Unload monitors discharging. The sheet format detection function compares the actual format to the target format after loading – which helps ensure reliable and safe processes.

Better punching, automatically

When automated, your TruPunch carries out punching operations even more productively – round the clock if necessary. This enables you to work with particular flexibility and ensures that you are ideally prepared for new requirements. Speaking of which: you can retrofit automation components from TRUMPF at any time.

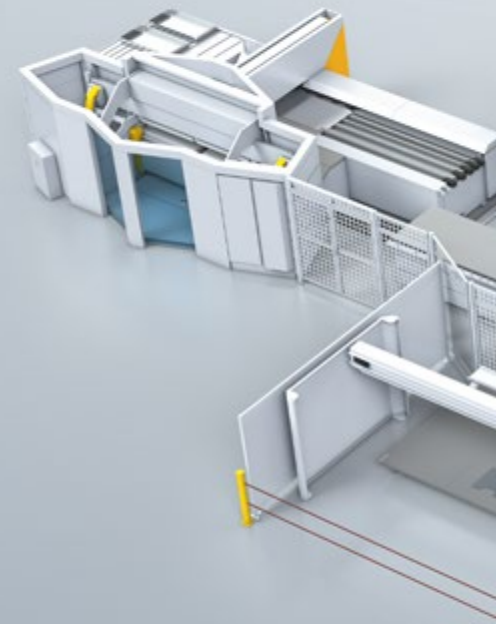

SheetMaster







This component loads and unloads your machine and reliably sorts parts – increasing the service life of your machine.

SheetMaster Compact

Automatically supplies your TruPunch with sheets and unloads grid residue. This enables you to use your machine more effectively.

ToolMaster Linear





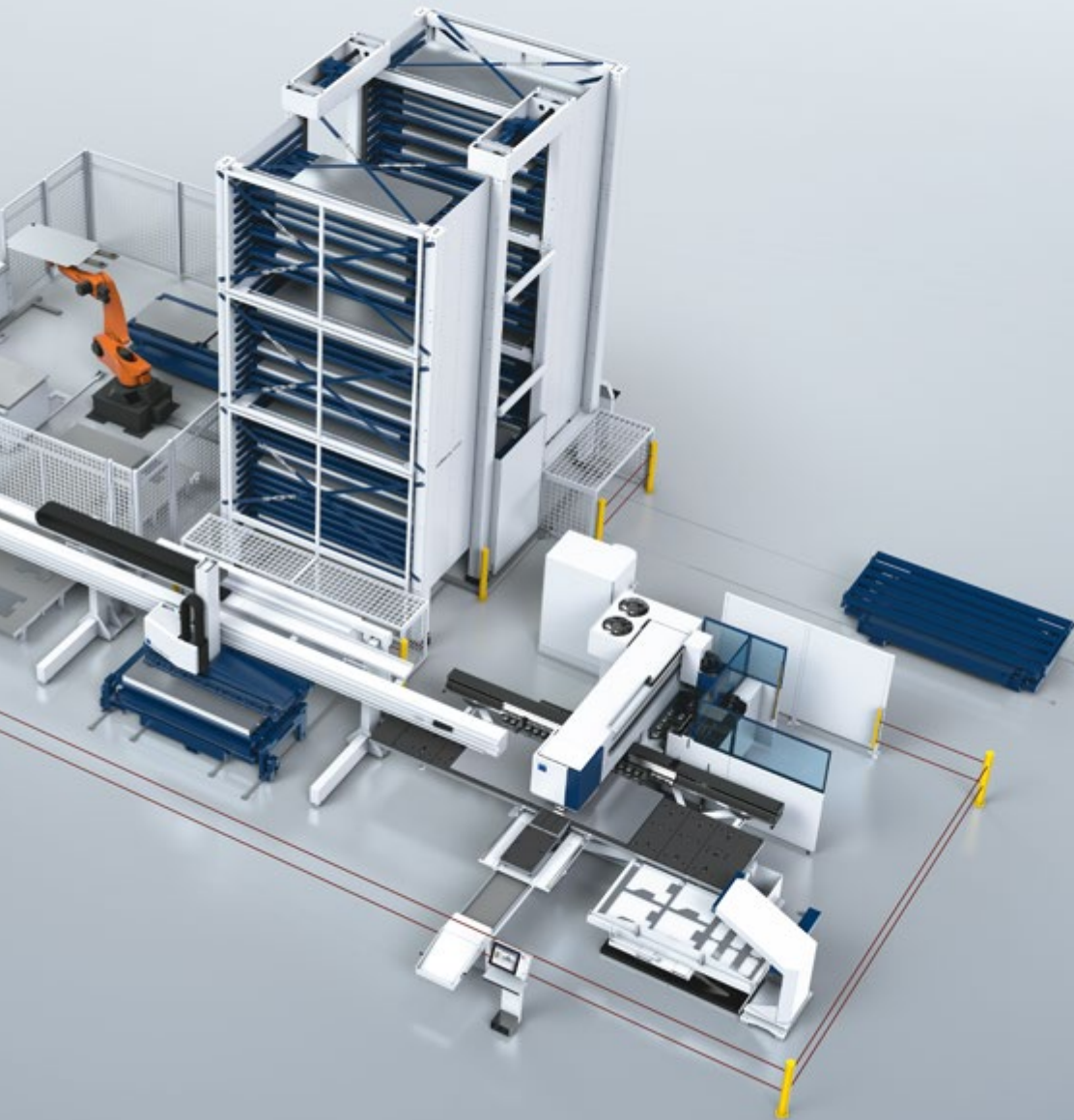

Gain additional tool capacity in order to complete your orders even more quickly.

Potential machines	SheetMaster	SheetMaster Compact	Cart systems	SortMaster Pallet	SortMaster Box	SortMaster Box Linear
						
Functions	Loading, unloading, sorting	Loading, unloading, sorting	Loading, unloading	Sorting	Sorting	Sorting
TruPunch 1000 (S19)		■				
TruPunch 3000	■	■				
TruPunch 5000	■		■	■	■	■



Automated punching with TRUMPF – save time and money. www.trumpf.com/s/v114xh

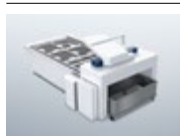
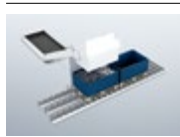

Sorting function	SortMaster Compact	ToolMaster Linear	GripMaster	ShearMaster	Dispose Master	TruStore and large-scale storage systems
						
Sorting	Unloading, sorting	Tool handling	Disposal	Disposal	Disposal	Storage and logistics systems
<input type="checkbox"/> <input type="checkbox"/>	<input type="checkbox"/> <input type="checkbox"/>	<input type="checkbox"/>	<input type="checkbox"/>	<input type="checkbox"/>	<input type="checkbox"/>	<input type="checkbox"/>



Sure-fire success

You have the choice – in every productivity class: from the efficient entry-level machine TruPunch 1000 to the productive high-end machine TruPunch 5000. Which one meets your requirements?



	TruPunch 1000 (S19)	TruPunch 3000	TruPunch 5000
Sheet thickness	6.4 mm		8 mm
Format	Medium format		
	Large format		
Productivity	+++	++++	+++++
Automation	Yes	Yes	Yes



You can also find the right machine for your requirements online: www.trumpf.com/s/avjtu2



TruPunch 1000 (S19)

The new TruPunch 1000 (S19) is radically different. Its automation options are unparalleled in its class. And the best part is that, in line with the development of your business, you can upgrade this machine into an equally compact punch laser production cell.

01

Innovative

thanks to patented Delta Drive

04

Top of its class

in discharging and sorting options

02

Saves space

by using 15% less floor space than the previous model

03

Secure for the future

through growing machine concept



01

Innovative

thanks to patented Delta Drive

Compact and dynamic – the drive has been completely redesigned by our developers. The patented Delta Drive makes it unnecessary to move the plate and supporting table in the Y-axis, as for the first time it enables the punching head to move back and forth, or to “fly”. This is made possible by a sophisticated drive system.

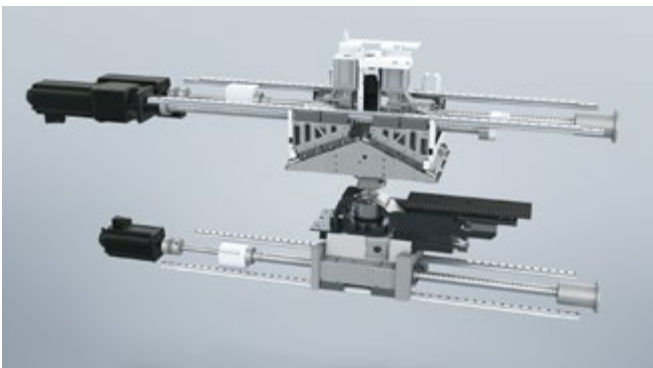

Delta Drive: This innovative drive concept offers novel processing and discharging options.

02

Saves space

by using 15% less floor space than the previous model

Compared to previous models, you reduce the space needed for the TruPunch (S19) by up to 15%. It remains compact even when equipped for loading and unloading: the parts containers are arranged to be space-neutral.

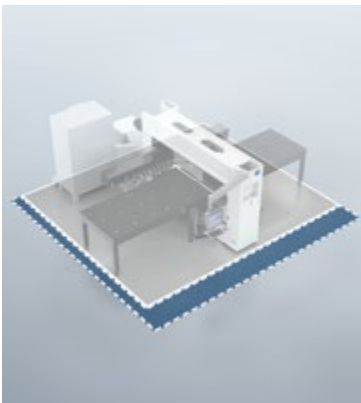

The TruPunch 1000 (S19) requires 15% less space than the previous model.

03

Secure for the future

through growing machine concept

Pave the way for your success: With the first modular machine concept for punching in the world, you are always able to react flexibly to changing order situations. You grow – and your machine grows with you.



By retrofitting the laser and adding additional components, the TruPunch 1000 (S19) can be converted into the TruMatic 1000 fiber.

04

Top of its class

in discharging and sorting options

The part removal flap enables you to automate the unloading of large parts. Conveyor belts transport the parts to the correct container. The machine automatically sorts good parts with sizes of up to 180 x 180 mm into waiting containers. Remove individual parts and stack them with SortMaster Compact. Individually controllable suction cups ensure safe removal.



You stack finished parts on standard load carriers with the SortMaster Compact.



Mehr zur TruPunch 1000 (S19): www.trumpf.com/s/trupunch-1000



TruPunch 3000

The compact TruPunch 3000 is your complete solution for versatile part processing. For anyone who would like to punch efficiently and yet economically.

01

Economically
punching

04

Simple operation
with Touchpoint HMI



02

Minimal material wear
thanks to descending die

03

Thoughtful
with removal and sorting solutions

01

Economically

punching

With the powerful, dynamic Delta Drive, the TruPunch 3000 works particularly productively. It eliminates the need to move the sheet and support table on the Y-axis, ensuring high productivity and process reliability.



Multiple advantages due to powerful Delta Drive.

02

Minimal material wear

thanks to descending die

The descending die enables scratch-free punching and re-shaping operations and eliminates the risk of parts getting caught. Brush beds and brushable part flaps also contribute to part quality.

03

Thoughtful

with removal and sorting solutions

Removal and sorting solutions take care of parts from small to large. The sorting flap separates good and scrap parts quickly and automatically. A large part removal flap enables automated unloading of parts up to a format of 400 x 600 mm. The SheetMaster Compact loads and unloads, the SortMaster Compact sorts finished parts.



SheetMaster Compact for automated loading.

04

Simple operation

with Touchpoint HMI

It can be very easy to produce punching parts – machine operation becomes as intuitive as when using a tablet or smartphone with the new Touchpoint HMI from TRUMPF. It helps you finish the part much more quickly – and even novices will quickly learn how to work with the software.



The Touchpoint HMI makes operation simple.



For more information about the TruPunch 3000:
www.trumpf.com/s/yzkqmo



TruPunch 5000

This high-end machine sets new standards: it is highly productive with maximum axis dynamics, and can flexibly provide the best possible part quality thanks to its retractable clamping claws and active die.

01

Powerful

reaches 1600 strokes/minute

04

Rapid tool change

with ToolMaster Linear

02

Quality and flexibility

thanks to the active die

03

Material efficiency

thanks to retractable clamping claws



01

Powerful

reaches 1600 strokes/minute

Thanks to the powerful hydraulic drive, you can carry out stamping operations at up to 1600 strokes per minute and etching operations at 2800 strokes per minute. Drives with zero play enable maximum axis acceleration. The high rotational speed of the C-axis enables you to carry out tapping extremely rapidly and to productively process complex contours.

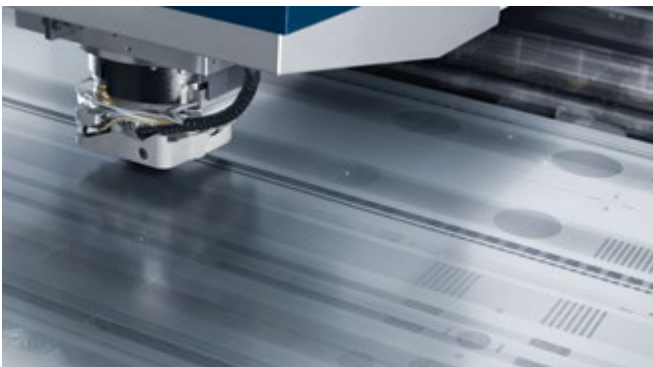

Maximum performance: The TruPunch 5000 is the fastest punching machine in the world.

02

Quality and flexibility

thanks to the active die

The reshaping die can be retracted for scratch-free processing. You can use reshaping tools with a minimum circumscribed circle of up to 100 mm and process your parts from below thanks to the active stroke axis.



The active die provides for active reshaping from below and enables scratch-free processing.

03

Material efficiency

thanks to retractable clamping claws

Retractable clamping claws ensure maximum part quality and precision. You can improve your material efficiency by using the protective areas when loading panels. This makes it usually unnecessary to change over the claws, increasing your productivity.



Retractable clamping claws ensure maximum utilization of each sheet.

04

Rapid tool change

with ToolMaster Linear

The ToolMaster Linear enables you to benefit from shorter processing times and a capacity of 18, 54 or 90 tool stations with the option for modular expansion. This provides you with exceptional flexibility for your punching operations – including automatic processing round the clock.

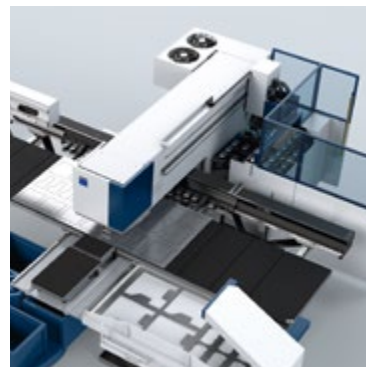

Automatic tool change with the ToolMaster Linear.



For more information about the TruPunch 5000:
www.trumpf.com/s/rbwhgq



Technical data

These pages provide you with a summary of the technical data of the TruPunch machines:

Technical data					
		TruPunch 1000 (S19)		TruPunch 3000	
		Medium format	Large format	Medium format	Large format
Working range	mm	2500 × 1250	3050 × 1550	2500 × 1250	3050 × 1550
Max. Sheet Thickness	mm	6.4	6.4	6.4	6.4
Max. effective punching force	kN	165	165	180	180
Axis speed (X and Y simultaneously)	m/min	100	100	108	108
Max. punching stroke rate (E = 1 mm)	1/min	600	600	800	690
Tools / with number of claws	Items	18/2	21/3	18/2	21/3
Tool change time for single tool	s	3.2	3.2	3.1	3.1
Tool change time	s	2.4	2.4	0.5	0.5
Positioning deviation	mm	0.1	0.1	0.1	0.1
Part discharge: Max. part size	mm	400 × 1250 ¹⁾	400 × 1250 ¹⁾	400 × 600	400 × 600
Part discharge: Max. part size with sliding table	mm	–	–	–	–
Space required	mm	6290 × 6550	7650 × 7670	6290 × 6550	7650 × 7670
Average power input in production	kW	3.5	3.5	3.5	3.5

¹⁾Reliable removal up to a max. part size of 400 mm × 600 mm.

Content subject to change without notice. The information in our offer and our order confirmation is authoritative.



TruPunch 5000	
Medium format	Large format
2500 × 1250	3050 × 1550
8	8
220	220
116	116
1600	1350
18/3	21/4
2.8	2.8
0.3	0.3
0.1	0.1
500 × 500	500 × 500
–	–
6540 × 7400	7620 × 8170
9.5	9.5

100% effective punching force

The effective punching force is the force that is effectively applied to your sheet. Thanks to the TRUMPF concept, the value for this is 100%. Contrary to the effective punching force, the often cited initial force that a tool applies to the punching head is less significant because, depending on the tool path, a lesser or greater proportion of the force is lost. It is therefore better to rely on the effective punching force – as that is what actually matters.



TruServices. Your partner in performance

To ensure your future success, you need services that definitely put you ahead of the pack for the long term. Whether that means creating the best conditions for successful production, or using your TRUMPF laser systems perfectly to adapt to changes with flexibility – together we'll find ways to sustainably maximize your value creation. As a reliable partner, we will provide you with comprehensive solutions and service packages for your requirements – so that you can produce cost effectively and at a constantly high level.



Comprehensive training program

Empower: If you wish to create the best conditions for successful manufacturing: We will support you in this. Use our comprehensive training program to expand your knowledge and get a competitive edge. Having the appropriate training enables you, for example, to program your punching machine more quickly.

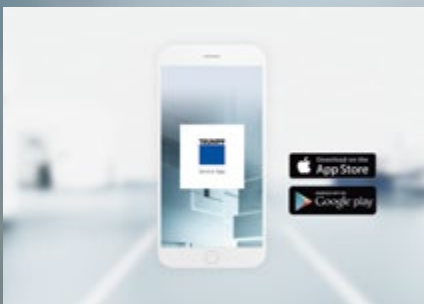

Technical Service: If flexibility and availability of equipment in day-to-day operations are essential to you: We are there for you. The Technical Service and the TRUMPF service networks will assist you. You can get in touch with us very easily, even via app.



Consulting on part design

Improve: If you want to gradually focus your manufacturing on maximum value creation: We will work together to reach your goal. Part design consultation, for instance, enables you to find out how you can reduce your manufacturing costs by up to 60% thanks to smarter sheet designs. What would you like to improve?



Financing

Training

Pre-owned machines

Technical Service

Tools

Genuine Parts

Design and Programming Software

Process optimization

Monitoring & Analysis

Product Enhancements

Value Packages

Service Agreements



Find out about our comprehensive complete package of helpful services:
www.trumpf.com/s/services



The best solution for your Smart Factory

Industry 4.0 is changing our professional world. How can you react to this increasing complexity in your production facility? With TruConnect you optimize your entire value-added process step by step. This is achieved by networking your production, not just digitally but also physically – from software, machines, and services to automation, storage, and logistic systems. Talk to us about the best production solution for your Smart Factory. You can find two example cases here:

Your requirement:

The solution:

You benefit from:



Discover the modular networking solutions from TRUMPF with **TruConnect**.
www.trumpf.com/smart-factory



Punching and bending production lines with coil connection

A direct chain from the coil to the bent sheet using “one piece flow”.

Combine your coil system, punching machine, and bending brake.

- No need to program the coil system
- Coil system communicates with the punching machine as an external loading unit
- Machines can be used within the chain as well as individually
- Buffers compensate for different machine cycle times (for example, use of a BendMaster for the bending brake)

Automation of oversize format parts

You want to load sheets up to 4000 × 1500 mm fully automatically, load sheet formats and finished parts in the same dimensions automatically, and unload sorted parts and automatically dispose of grid residue up to 4000 × 1500 mm.

You can for instance combine a TruPunch 5000 and a SheetMaster.

- You enjoy increased flexibility in your production facility
- You can adjust your production facility to suit different sheet formats in no time at all
- You can easily master short job changes and small batch sizes

Passion is what drives us

Whether it's production and manufacturing technology, laser technology, or material processing – we develop highly innovative products and services which are suitable for industry and absolutely reliable. We put everything we've got into giving you a compelling and competitive edge – expertise, experience, and a lot of passion.



Visit us on YouTube:
www.youtube.com/TRUMPFtube



Lasers for manufacturing technology

Whether macro, micro or nano: We have the right laser and the right technology for any industrial application, allowing you to manufacture in an innovative yet cost-efficient manner. Beyond the technology itself, we support you with system solutions, application knowledge, and consulting.



Power-supply systems for high-tech processes

From semi-conductor production to manufacturing solar cells: Our high- and medium-frequency generators give electricity for induction heating, plasma and laser excitation a defined form based on frequency and demand – highly reliable and for repeat accuracy.



Machine tools for flexible sheet metal and tube processing

Whether it's laser cutting, punching, bending, or laser welding – we offer tailor-made machines and automation solutions, including consulting, software, and services, for all processes in flexible sheet metal processing – so you can reliably manufacture your products to exacting quality standards.



Industry 4.0

The TruConnect range of solutions connects man and machine through information. It covers all steps in the production process – from the offer right through to the shipping of your parts.

TRUMPF is certified to ISO 9001
(Find out more: www.trumpf.com/s/quality)



TRUMPF Werkzeugmaschinen SE + Co. KG
www.trumpf.com