

Standard specifications

RS006LFF60

1st Edition : January 12, 2017
2nd Edition : July 31, 2017
3rd Edition : May 10, 2018

KAWASAKI HEAVY INDUSTRIES, LTD.
ROBOT DIVISION

Specification :	90101-2622DEC
(Arm) :	90151-0046DEB
(Controller) :	90152-0048DEB

1. Specification of Robot

[1] Robot Arm

1. Model	RS006L-A		
2. Type	Articulated robot		
3. Degree of freedom	6 axes		
4. Axis specification	Operating axis	Max. operating range	Max. speed
	Arm rotation (JT1)	+180° ~ -180°	250°/s
	Arm out-in (JT2)	+145° ~ -105°	250°/s
	Arm up-down (JT3)	+150° ~ -163°	215°/s
	Wrist swivel (JT4)	+270° ~ -270°	365°/s
	Wrist bend (JT5)	+145° ~ -145°	380°/s
	Wrist twist (JT6)	+360° ~ -360°	700°/s
5. Repeatability	±0.03 mm (at the tool mounting surface)		
6. Max. payload	6 kg		
7. Max. speed	13700 mm/s (at the center of tool mounting surface)		
8. Load capacity of wrist		Max. torque	Moment of inertia*
	JT4	13 N·m	0.45 kg·m ²
	JT5	13 N·m	0.45 kg·m ²
	JT6	7.5 N·m	0.14 kg·m ²
Note* Each value in this table shows allowable moment of inertia of JT4/JT5/JT6 when max. allowed torque is applied to each axis. If more detailed data is required for your application, please contact Kawasaki.			
9. Driving motor	Brushless AC Servomotor		
10. Working range	See attached drawing		
11. Mass	150 kg (without options)		
12. Color	Munsell 10GY9/1 equivalent		
13. Installation	Floor or Ceiling mounting		
14. Environment cond.	(Temperature) 0 ~ 45 °C, (Humidity) 35 ~ 85 %, no dew, nor frost allowed		
15. Degree of protection	Wrist : IP67 Arm : IP65		
16. Built-in utilities	Pneumatic pipings (φ 8 × 2 lines)		
17. Options	Wall mounting installation		
	Degree of protection of arm : IP67		
	Sensor harness (12 circuits), wired inside robot arm		
	Double solenoid/ Single solenoid valves (4 units max.)		
	Air cleaning equipment (filter, regulator, mistseparator)		
	Adjustable mechanical stoppers JT1/JT2/JT3		
	Color (Munsell)		
	Traverse unit (Stroke mm)		
	Arm installation stand (height 600 mm, 300 mm)		
	Arm installation plate (750 mm × 750 mm)		
18. Others	Consult Kawasaki about maintenance parts and spare parts.		

[2] Controller		
1. Model	F60	
2. Enclosure	Protection level: IP20 Open structure / Direct cooling system *1	
3. Dimensions	See attached drawing	
4. Number of controlled axes	Max.8 axes (standard 6 axes, option 2 axes)	
5. Servo control and drive system	Full Digital Servo System	
6. Type of control	Teach mode Joint, Base, Tool, Fixed Tool (option) operation mode	
	Repeat mode Joint, Linear, Circular (option) interpolation	
7. Teaching method	Teaching or AS language programming	
8. Memory capacity	16 MB	
9. External operation signals	External Emergency stop, External Hold, etc.	
10. Number of Option board slots	2 slots	
11. Operation panel	Teach/Repeat SW, Emergency Stop SW	
12. Communication I/F	Ethernet (1000BASE-T/100BASE-TX/10BASE-T)	2port
	USB2.0	3port
	RS-232C	2port
13. Mass	See attached drawing	
14. Power requirement	AC200 V - AC230 V±10%, 50/60 Hz, 1 phases, Max. 2.0 kVA	
15. Ground	Less than 100 Ω (robot dedicated ground) Leakage current: max. 100 mA	
16. Ambient temperature	0 - 45°C	
17. Relative humidity	35 - 85 % (non-condensation)	
18. Color	Munsell: 5Y8.5/1 equivalent	
19. Teach Pendant	TFT color display (5.7 inch LCD) with touch panel Emergency Stop SW, Teach Lock SW and Enable SW	
20. Safety Circuit	Category: 4, Performance Level: e (EN ISO13849-1) *2	
21. Number of General purpose I/O signals	IN:16 OUT:16 with an I/O connector. (50pin with cover)	
22. Standard Options		
TP sheet language	English or Japanese or Chinese	
Power/Signal cable	5m, 10m, 15m	
Teach Pendant cable	5m, 10m, 15m	
23. Other Options		
Number of additional I/O signals	Inside Controller	I/O board(IN:32 OUT:32) ...up to 2 boards
	Remote I/O	Remote I/O unit(IN:32 OUT:32) ...up to 4 units
	Total max I/O number	IN:128 OUT:128
Intake Filter	Dusts more than 1mm diameter do not get into the controller from intake FAN	
Enclosure	Protection level: IP54 Enclosed structure / Indirect cooling system (Ambient temperature 0 - 45 °C) *3	
Motor brake release	Manual brake release switch BOX	
PC cable (RS-232C)	1.5 m, 3 m	
External axes control	Additional amplifier and harnesses for external axes	
Extended safety functions	Cubic-S(Motion area monitoring, Joint monitoring, Speed monitoring etc.) *3	
Teach Pendant option	Connector for TP less	
Fast check mode	Fast check mode Switch	
Others	Field BUS, Software PLC, Analog input/output, Conveyor Synchronization, Bluetooth	
24. Others	Consult Kawasaki about maintenance parts and spare parts.	

NOTE*1

Cooling of the electronic components in this open construction F60 controller is achieved by circulation of ambient air.

The enclosure is designed to protect personnel from coming in contact with hazardous parts inside the controller.

There is no protection to less than 10 mm of alien substance and water.

Please consider ①② and ③ and select the option about protection to the environmental specification

① There is no or few non-conductive dusts & particles(influence for the controller is little) ...Option is not needed.

② There is high possibility that non-conductive dusts & particle will get into controller. ...Select the option Intake Filter or Enclosed structure

③ There is high possibility that conductive dusts & particle will get into controller. ...Select the option Enclosed structure

NOTE*2

Category and Performance level (PL) are determined by the whole system and conditions.

The safety circuit of this controller is available in the system of category: up to 4, PL: up to e.

NOTE*3

Attaching additional unit makes size of a controller larger.

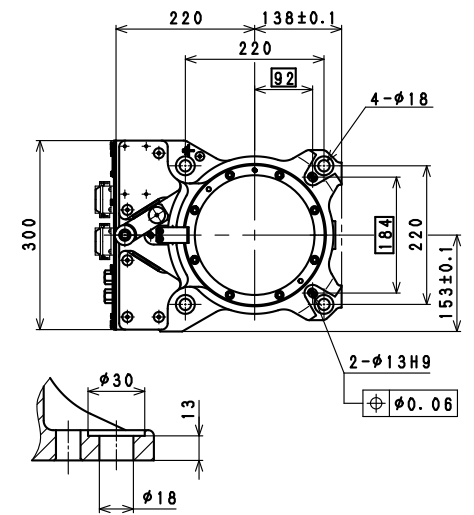
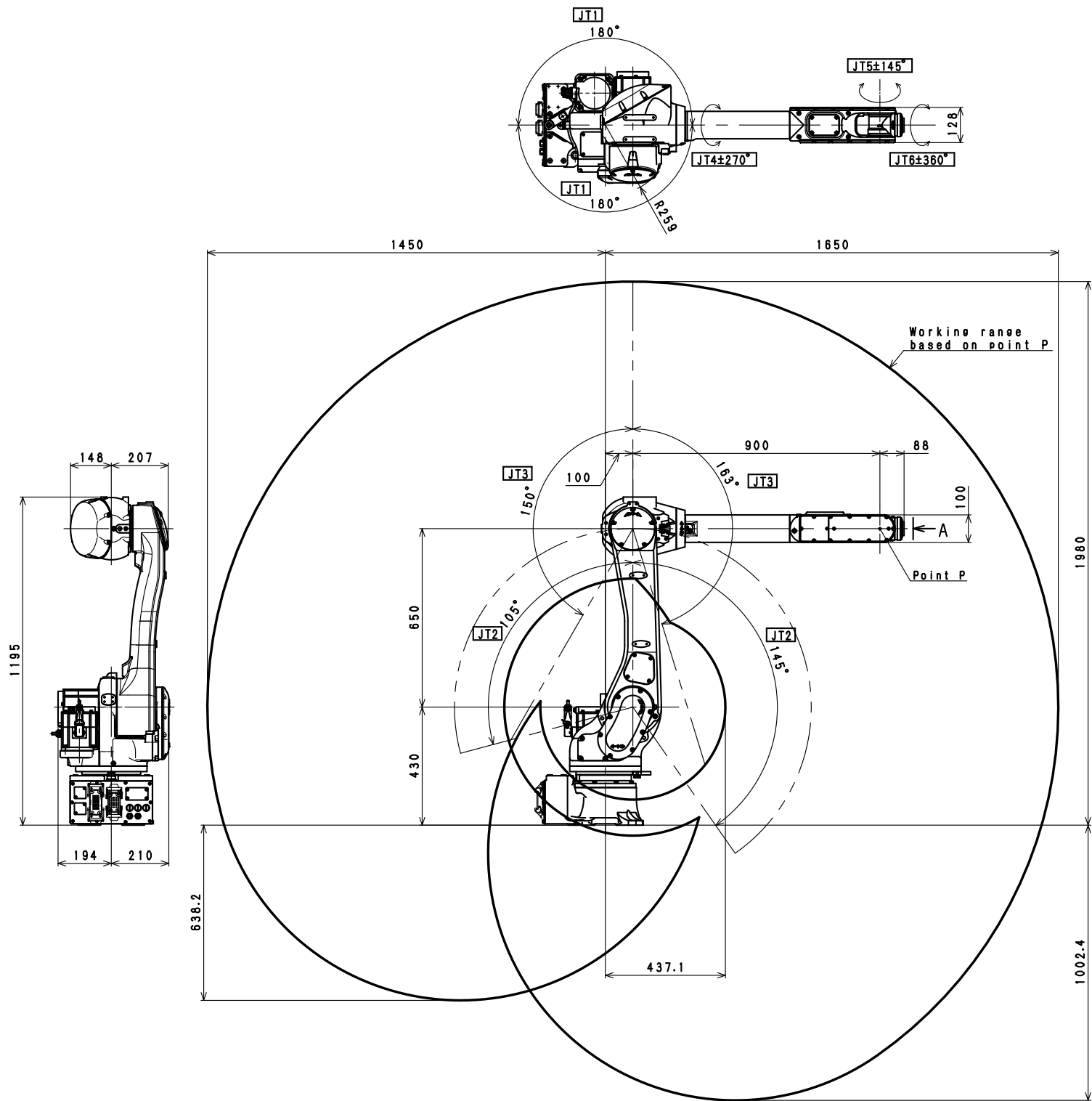

Installation Dimensions

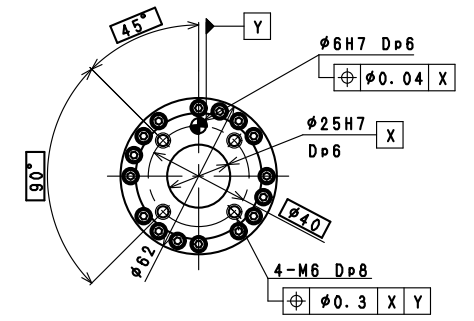

VIEW A

RS006L
WORKING RANGE

F60 CONTROLLER

MASS: 8.3Kg (Without any options)

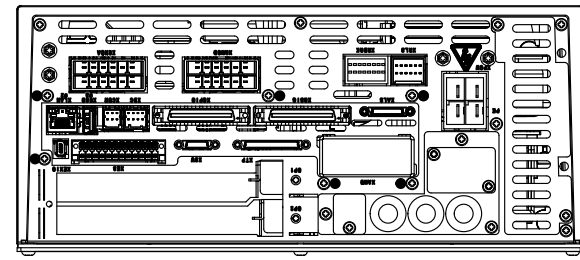

REAR VIEW

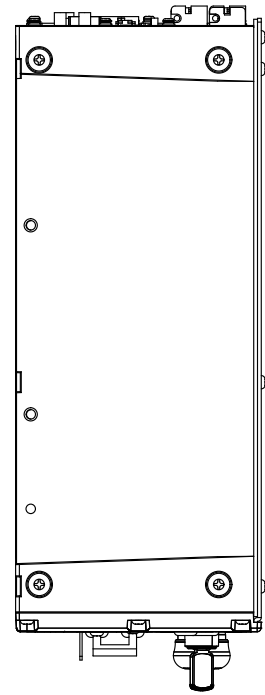

SIDE VIEW

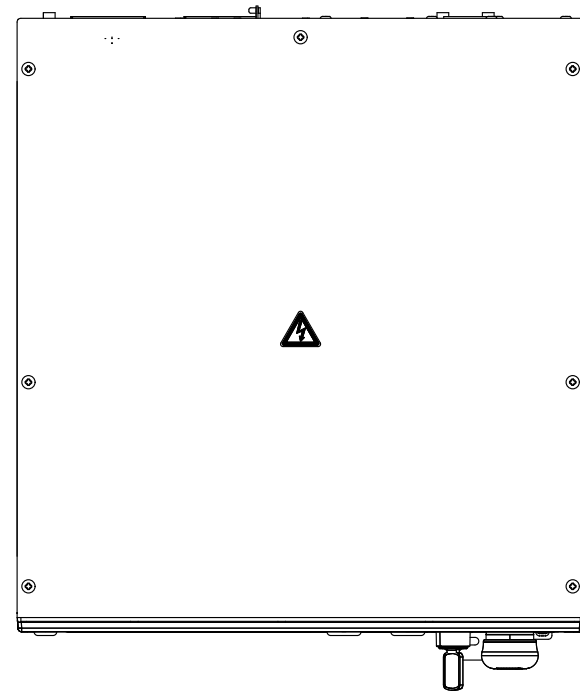

TOP VIEW

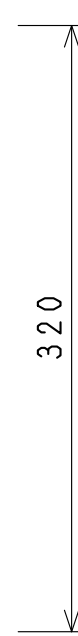

320

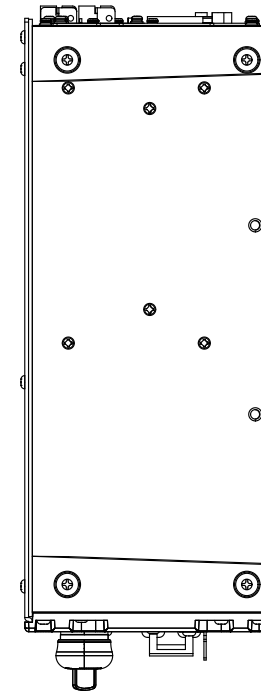

SIDE VIEW

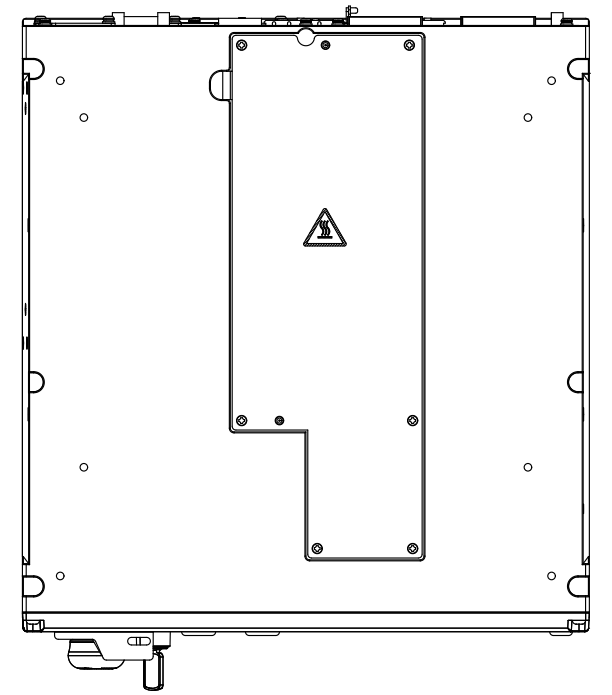

BOTTOM VIEW

Vertical Mount

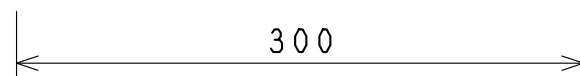
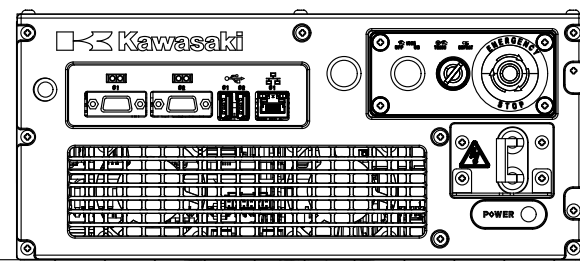
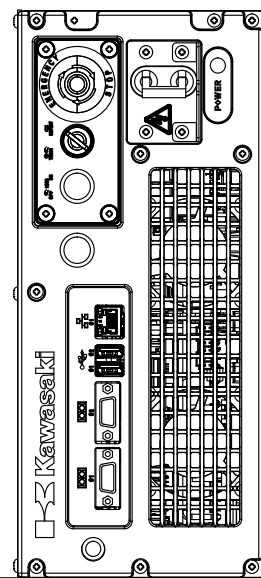

300

FRONT VIEW

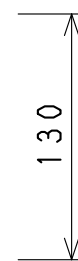

130

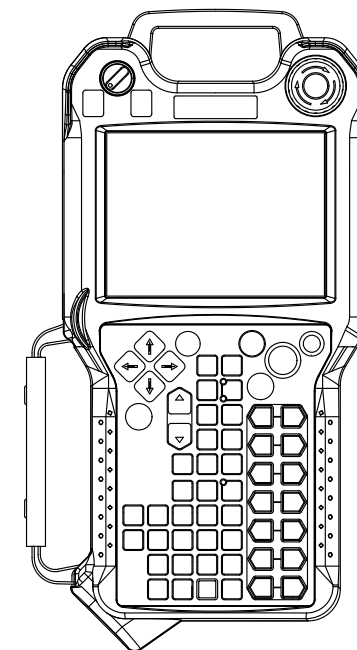

① Open Structure
Standard

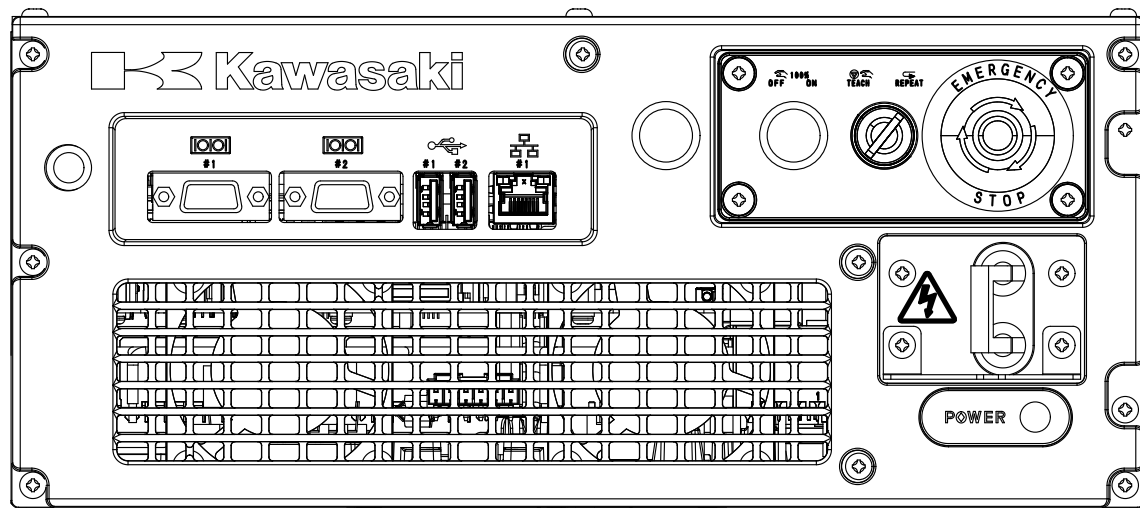

② Open Structure
With Intake Filter

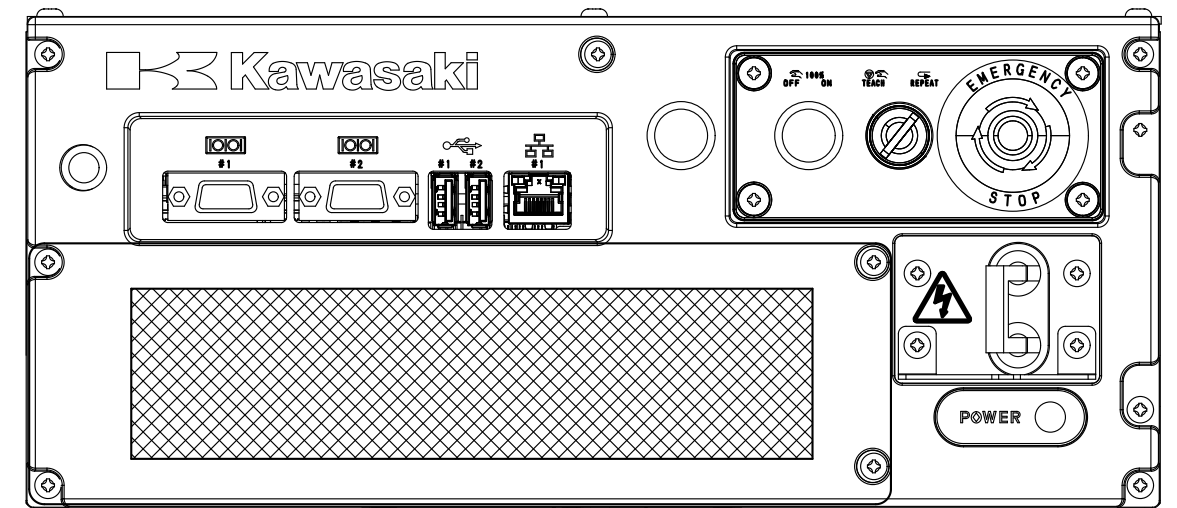

③ Enclosed Structure

F60 CONTROLLER

MASS: 16Kg
(With Enclosed Structure option)

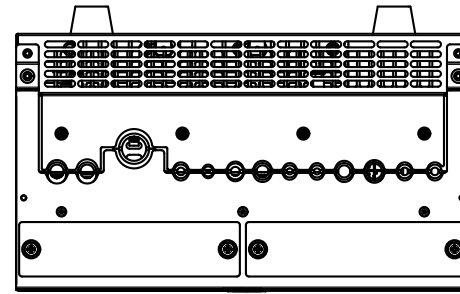

REAR VIEW

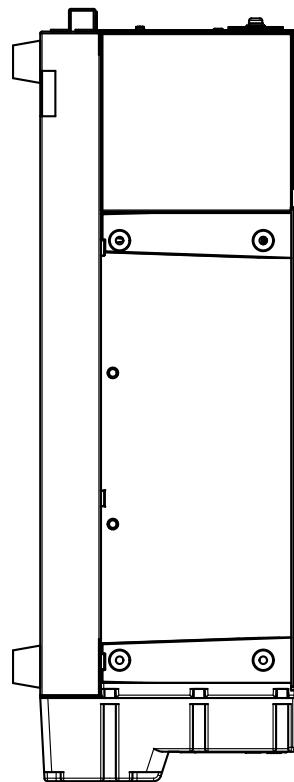

SIDE VIEW

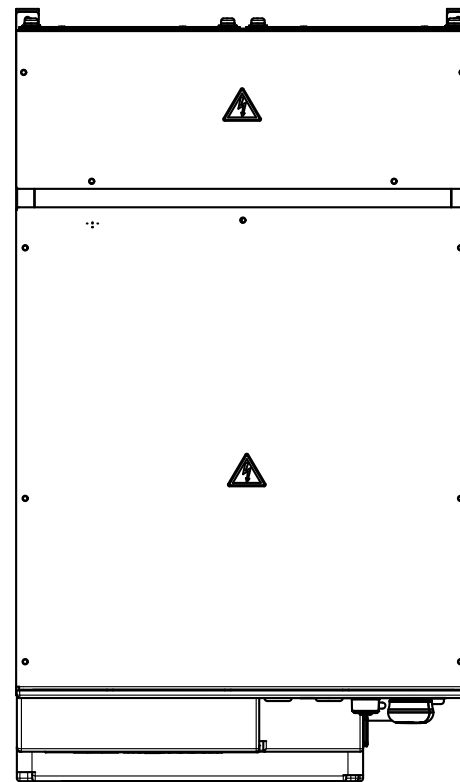

TOP VIEW

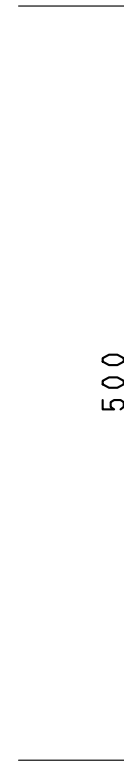

500

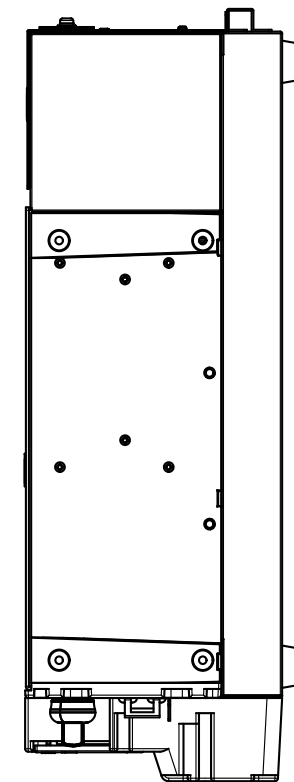

SIDE VIEW

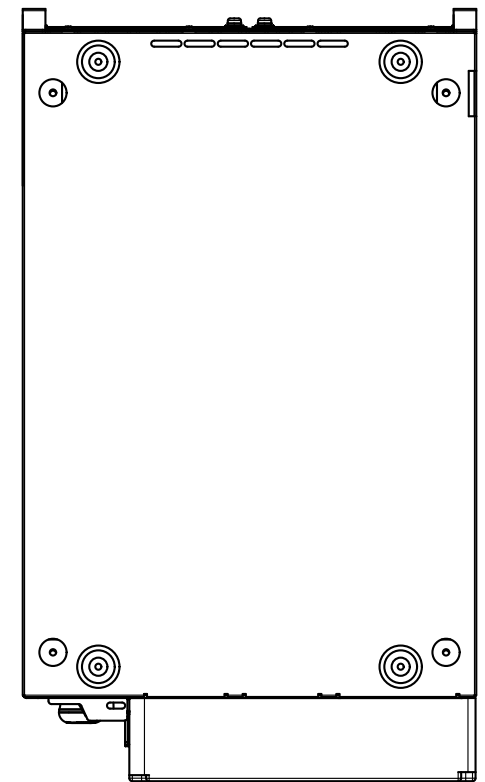

BOTTOM VIEW

Vertical Mount

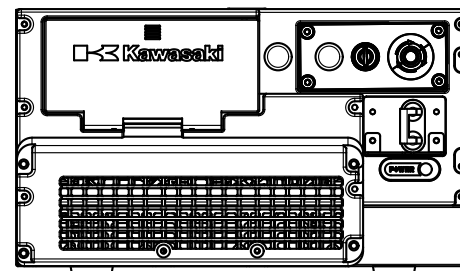
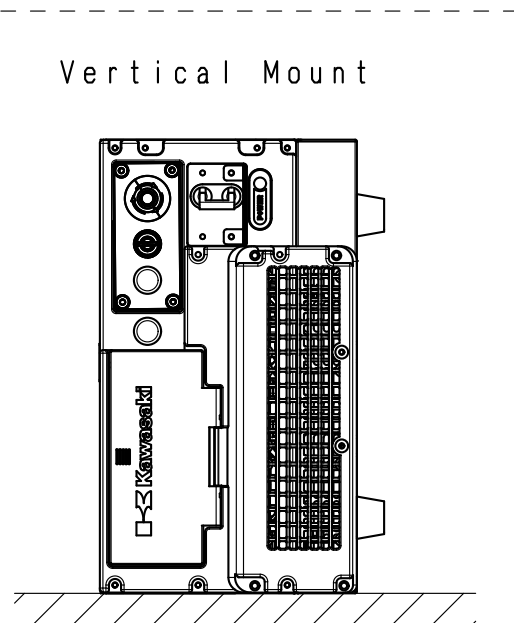

FRONT VIEW

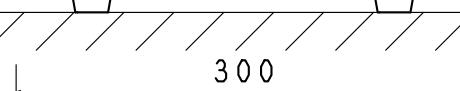

300

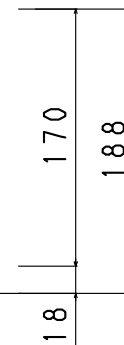

170

188

18